

# Juniper

## JN0-663 Exam

### Service Provider Routing and Switching, Professional (JNCIP-SP)



**Thank you for Downloading JN0-663 exam PDF Demo**

**You can Buy Latest JN0-663 Full Version Download**

<https://www.certkillers.net/Exam/JN0-663>

<https://www.certkillers.net>

## Version: 6.0

### Question: 1

Exhibit:

The exhibit shows a network diagram and configuration snippets for two routers, R1 and R2, connected via their ge-0/0/0 and ge-0/0/1 interfaces. The configuration for R2 is as follows:

```

user@R2# show interfaces
ge-0/0/0 {
  unit 0 {
    family iso;
    family inet6 {
      address 2001:db8::2/64;
    }
  }
}
ge-0/0/1 {
  unit 0 {
    family inet {
      address 172.16.2.2/24;
    }
    family iso;
    family inet6 {
      address 2001:db8:1::2/64;
    }
  }
}
user@R2# show protocols isis
interface ge-0/0/0.0;
interface ge-0/0/1.0;
interface lo0.0 {
  passive;
}
topologies ipv6-unicast;
  
```

The configuration for R1 is as follows:

```

user@R1# show interfaces
ge-0/0/0 {
  unit 0 {
    family iso;
    family inet6 {
      address 2001:db8::1/64;
    }
  }
}
ge-0/0/1 {
  unit 0 {
    family iso;
    family inet6 {
      address 2001:db8:1::1/64;
    }
  }
}
user@R1# show protocols isis
interface ge-0/0/0.0;
interface ge-0/0/1.0;
interface lo0.0 {
  passive;
}
topologies ipv6-unicast;
  
```

A network administrator is migrating from IPv4 to IPv6 and one of the IS-IS adjacencies is not coming up between R1 and R2.

Which action will solve the problem?

- A. Configure an IPv4 address on interface ge-0/0/1 on R1.
- B. Configure topologies ipv4-unicast from protocols isis on R2.
- C. Remove topologies ipv6-unicast from protocols isis on R1.
- D. Remove topologies ipv6-unicast from protocols isis on R2.

**Answer: A**

### Question: 2

Exhibit:

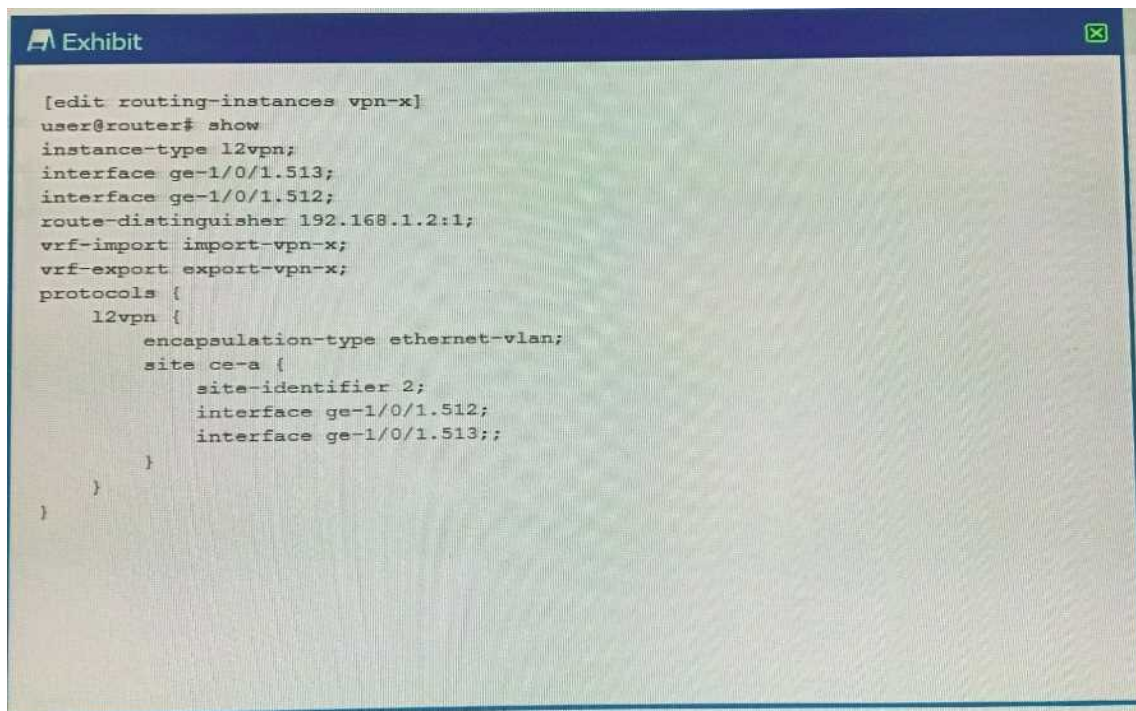

```
[edit routing-instances vpn-x]
user@router# show
instance-type l2vpn;
interface ge-1/0/1.513;
interface ge-1/0/1.512;
route-distinguisher 192.168.1.2:1;
vrf-import import-vpn-x;
vrf-export export-vpn-x;
protocols {
  l2vpn {
    encapsulation-type ethernet-vlan;
    site ce-a {
      site-identifier 2;
      interface ge-1/0/1.512;
      interface ge-1/0/1.513;;
    }
  }
}
```

You have the Layer 2 VPN configuration shown in the exhibit. You are asked to determine the remote site ID for ge-1/0/1.512.

In this scenario, what is the remote site ID?

- A. 5
- B. 3
- C. 1
- D. 4

---

**Answer: C**

---

---

**Question: 3**

---

Exhibit:

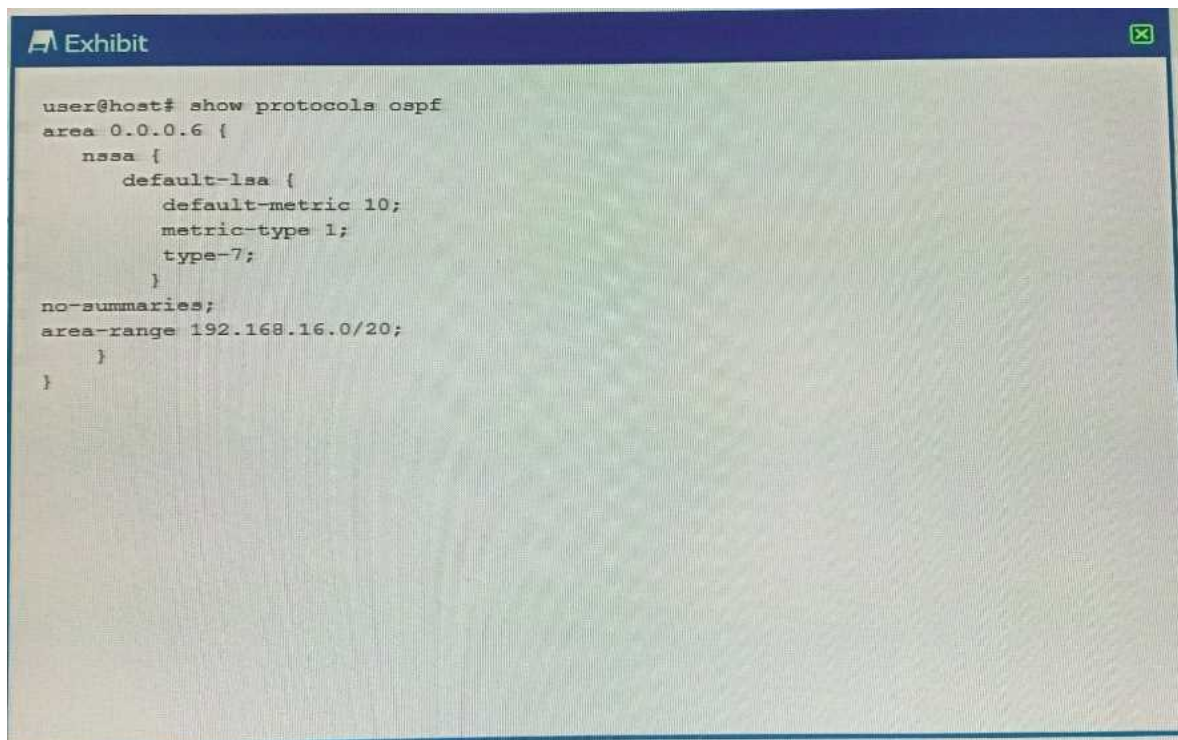

```
user@host# show protocols ospf
area 0.0.0.6 {
  nssa {
    default-lsa {
      default-metric 10;
      metric-type 1;
      type-7;
    }
  }
  no-summaries;
  area-range 192.168.16.0/20;
}
}
```

Referring to the ABR configuration shown in the exhibit, which three statements are correct? (Choose three.)

- A. The ABR advertises a default route to the NSSA using a Type 7 LSA.
- B. The ABR advertises a single Type 5 external LSA to the backbone area for all Type 7 LSAs in the NSSA.
- C. The ABR does not summarize any routes within the 192.168.16.0/20 range.
- D. The ABR advertises a Type 5 external LSA to the backbone area for each Type 7 LSA in the NSSA.
- E. The ABR advertises a single Type 3 summary LSA to the backbone area for all Type 1 and Type 2 LSAs in the 192.168.16.0/20 range.

---

**Answer: A, D, E**

---

---

**Question: 4**

---

Exhibit:

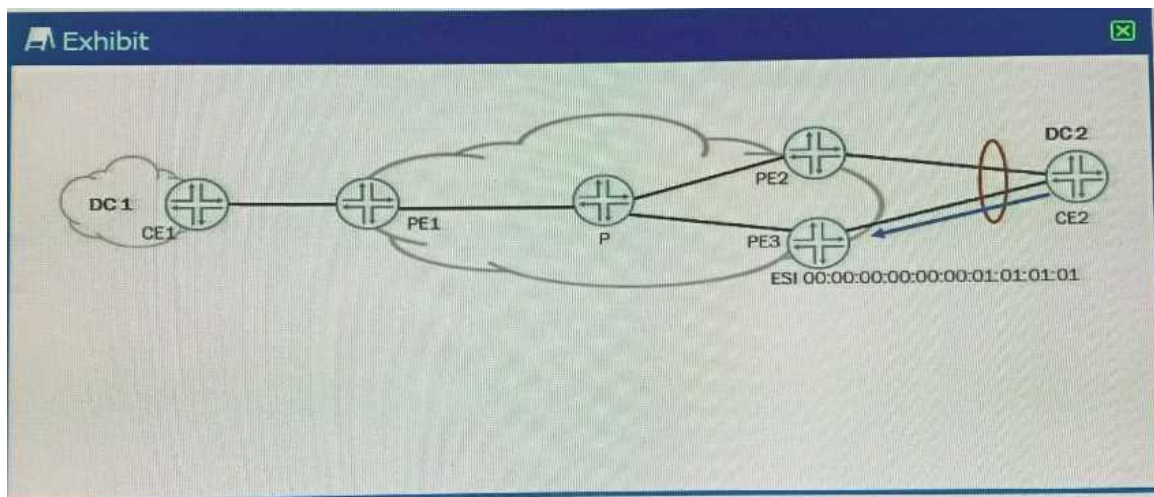

Referring to the exhibit, traffic sent from CE-A2 to PE3 does not loop back to CE-A2 through PE2. Which two EVPN functions accomplish this task? (Choose two.)

- A. split horizon
- B. aliasing
- C. multicast ingress replication
- D. designated forwarder election

**Answer: A, D**

**Question: 5**

Exhibit:

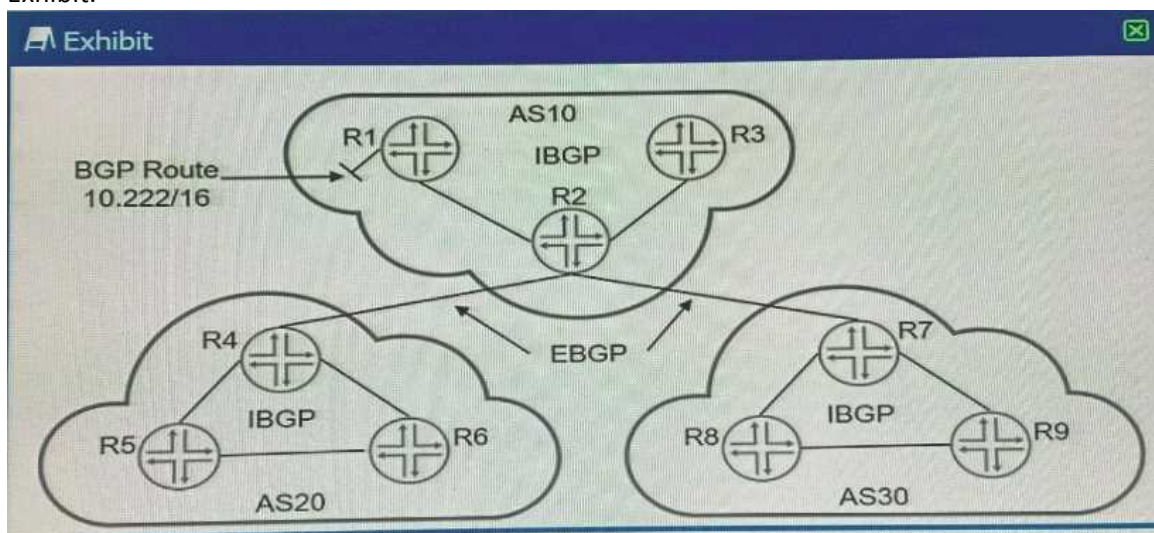

Referring to the exhibit, which three statements about route 10.222/16 are correct when using the default BGP advertisement rules? (Choose three)

- A. R2 will advertise 10.222/16 to R4 with itself as the next hop.
- B. R2 will prepend AS10 when advertising 10.222/16 to R7.
- C. R7 will advertise 10.222/16 to R9 with itself as the next hop.

- D. R1 will advertise 10.222/16 to R2 with itself as the next hop.
- E. R1 will prepend AS10 when advertising 10.222/16 to R2.

---

**Answer: A, B, D**

---



---

**Question: 6**

---

Exhibit:

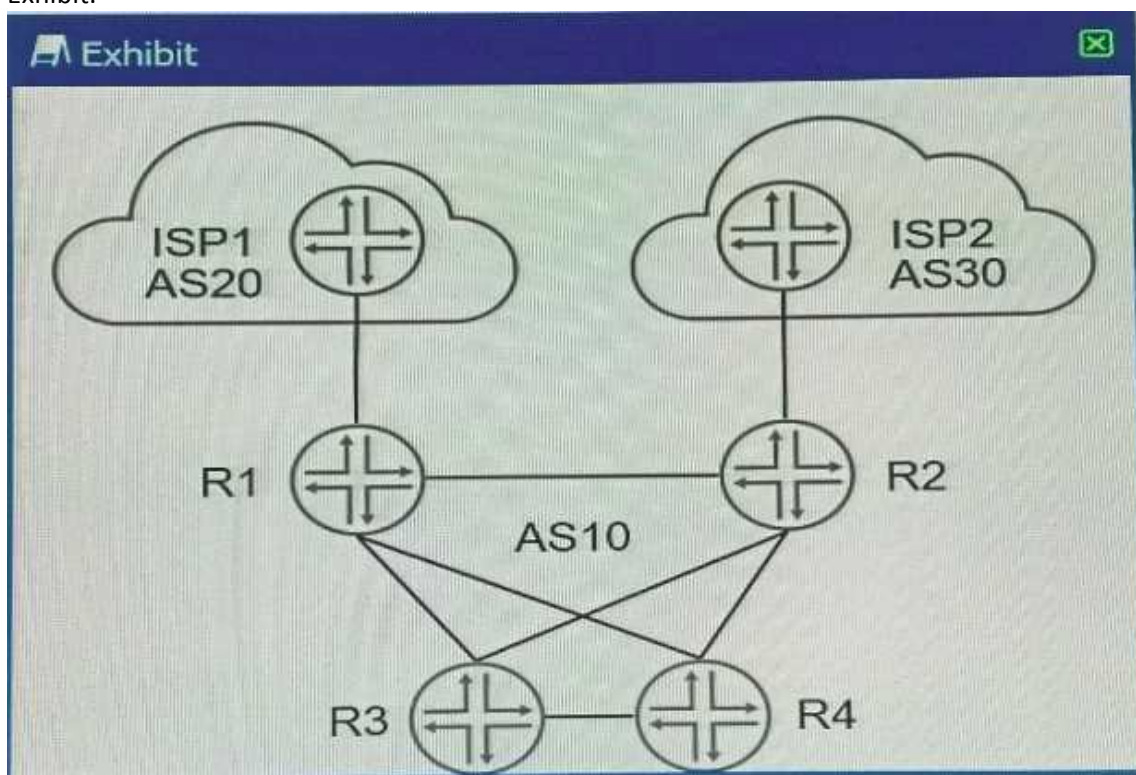

Referring to the exhibit, you want to make ISP1 your preferred connection for inbound and outbound traffic.

Which two steps will accomplish this task? (Choose two.)

- A. Create an export policy to prepend the ASN on advertised routes and apply it to the EBGP peer on R1.
- B. Create an export policy setting local-preference 200 and next-hop self and apply it to the IBGP peers on R1.
- C. Create an export policy to prepend the ASN on advertised routes and apply it to the EBGP peer on R2.
- D. Create an export policy setting local-preference 200 and next-hop self and apply it to the IBGP peers on R2.

---

**Answer: B, C**

---



---

**Question: 7**

---

You are responsible for configuring CoS for your network. Your network includes a video application with strict latency requirements, so that any packets delayed by more than 75 ms are effectively useless. You want to ensure that you do not waste buffer space.

When configuring the scheduler for this application, which feature would you use?

- A. exact
- B. remainder
- C. rate limit
- D. temporal

---

**Answer: D**

---

---

### Question: 8

---

Exhibit:

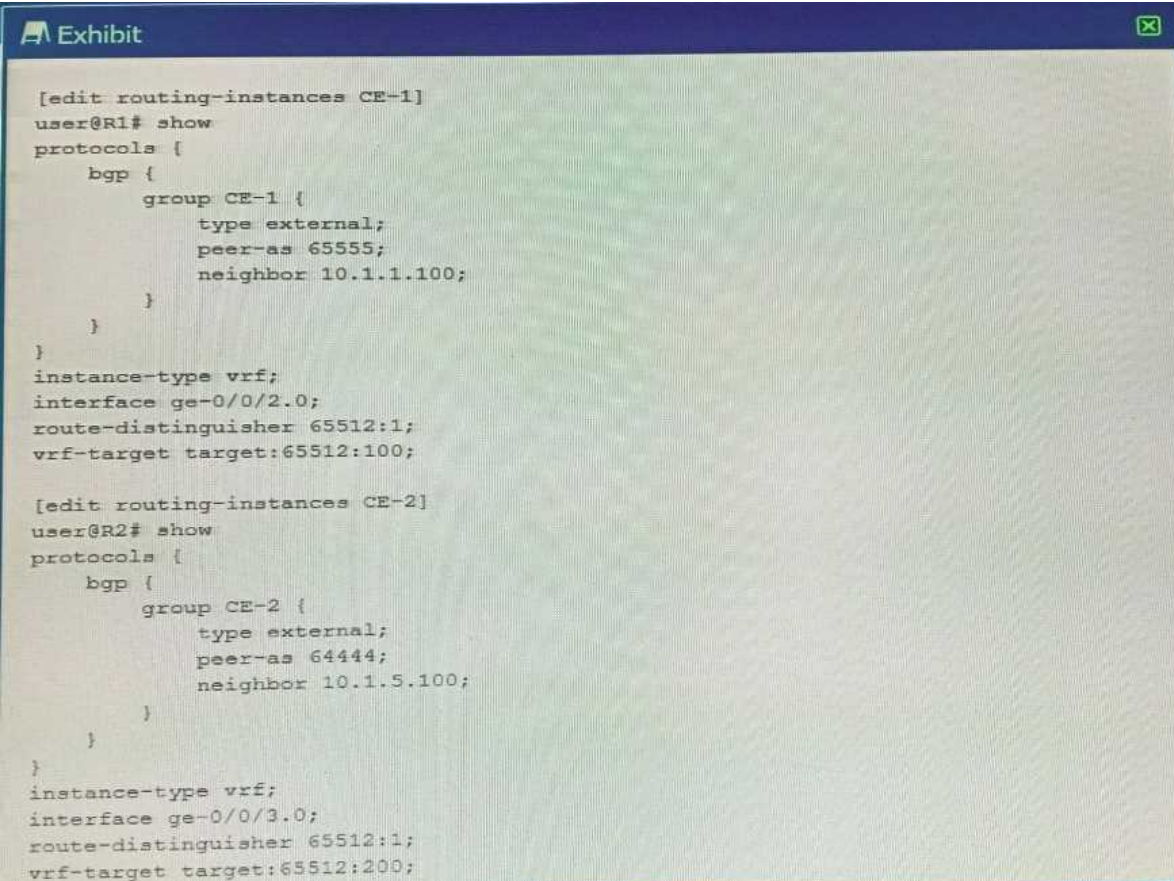

```
[edit routing-instances CE-1]
user@R1# show
protocols {
  bgp {
    group CE-1 {
      type external;
      peer-as 65555;
      neighbor 10.1.1.100;
    }
  }
}
instance-type vrf;
interface ge-0/0/2.0;
route-distinguisher 65512:1;
vrf-target target:65512:100;

[edit routing-instances CE-2]
user@R2# show
protocols {
  bgp {
    group CE-2 {
      type external;
      peer-as 64444;
      neighbor 10.1.5.100;
    }
  }
}
instance-type vrf;
interface ge-0/0/3.0;
route-distinguisher 65512:1;
vrf-target target:65512:200;
```

Referring to the exhibit, which two statements are true? (Choose two.)

- A. The vrf-target configuration stops routes from being shared between CE-1 and CE-2.
- B. The route-distinguisher configuration allows routes to be shared between CE-1 and CE-2.
- C. The vrf-target configuration allows routes to be shared between CE-1 and CE-2.
- D. The route-distinguisher configuration stops routes from being shared between CE-1 and CE-2.

---

**Answer: A, B**

---



---

**Question: 9**

---

Exhibit:

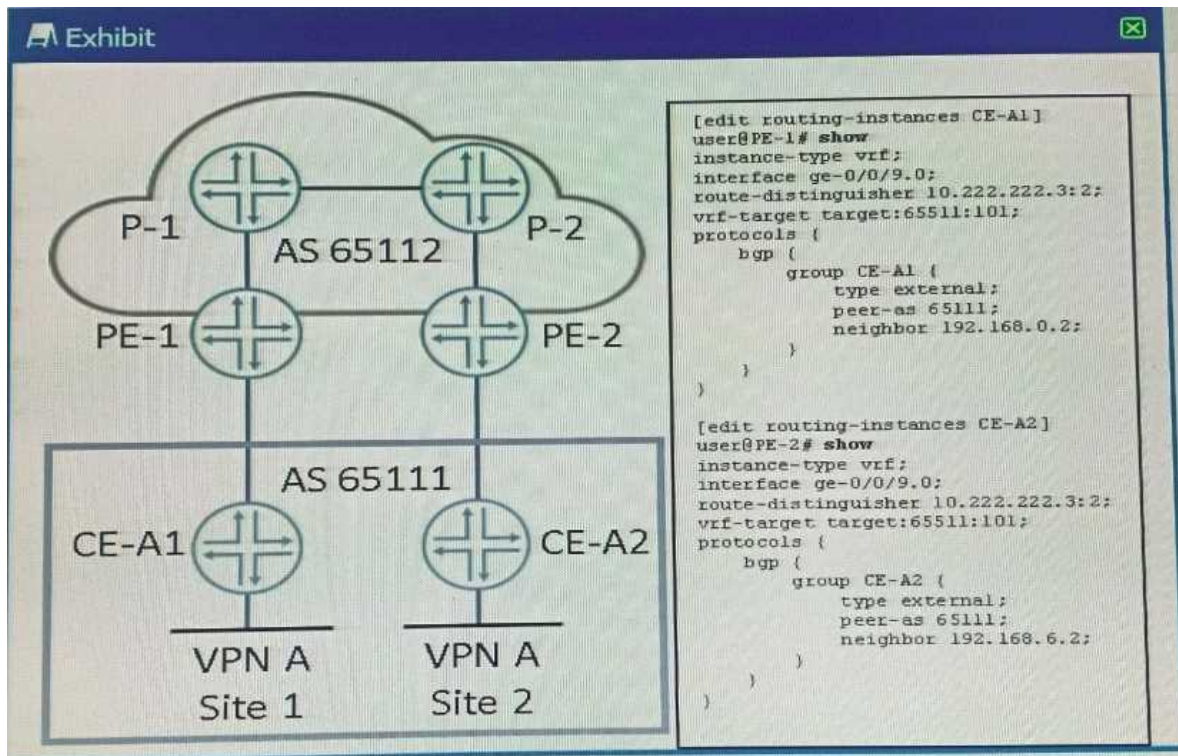

Referring to the exhibit, hosts in Site 1 and Site 2 are unable to communicate with each other through the Layer 3 VPN.

What is the problem?

- A. The two sites are using the same route distinguishes.
- B. The two sites are in the same AS.
- C. The two sites are using the same instance type.
- D. The two sites are using the same route target.

---

**Answer: B**

---



---

**Question: 10**

---

Exhibit:



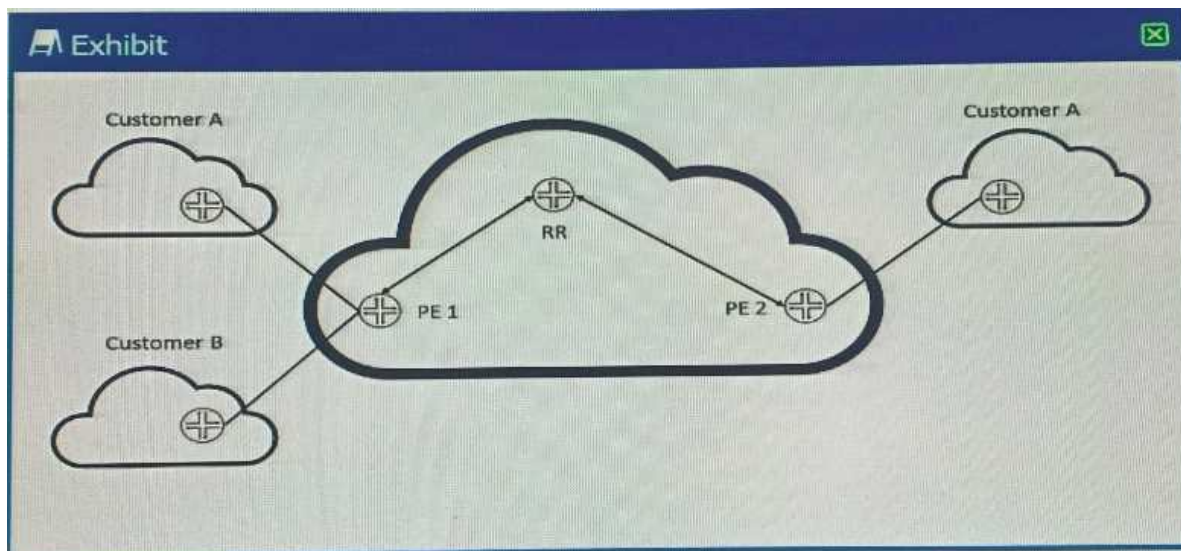

Referring to the exhibit, you want to reduce the CPU processing load on PE 2 by preventing the receipt of routes belonging to Customer B.

In this scenario, which Layer 3 VPN scaling mechanism provides this functionality?

- A. route origin
- B. route reflection
- C. route target filtering
- D. route refresh

---

**Answer: C**

---

## Thank You for trying JN0-663 PDF Demo

To Buy Latest JN0-663 Full Version Download visit link below

<https://www.certkillers.net/Exam/JN0-663>

## Start Your JN0-663 Preparation

**[Limited Time Offer]** Use Coupon “CKNET” for Further discount on your purchase. Test your JN0-663 preparation with actual exam questions.

<https://www.certkillers.net>